

VACUUM CUPS

HIGH-PERFORMANCE, ENERGY SAVING, COMPACT & LIGHTWEIGHT

A wide variety of vacuum cups are available. The cups use NPR-Neoprene Rubber and are designed for high performance and accuracy. Magnets are also available, for use when vacuum pick up is unsuitable.



Vacuum Cups

Type	Model	Parts No.	øD	H	Lifting Capacity	Horiz./Vert.
A	YC-AE02	T5426	2X5 mm (0.078X0.19")	12 mm (0.47")	0.06 mm (0.002")	0.03 mm/0.01 mm (0.001"/0.0003")
	YC-AE03	T5301	3X5 mm (0.11"X0.19")	12 mm (0.47")	0.09 mm (0.003")	0.04 mm/0.02 mm (0.001"/0.0007")
	YC-AE07	T5302	7X10 mm (0.27"X0.39")	12 mm (0.47")	0.41 mm (0.016")	0.20 mm/0.10 mm (0.007"/0.0039")
	YC-AE09	T5303	9X25 mm (0.35"X0.98")	12 mm (0.47")	1.44 mm (0.056")	0.72 mm/0.36 mm (0.028"/0.014")
	YC-AE15	T5427	15X25 mm (0.59"X0.98")	12 mm (0.47")	2.27 mm (0.089")	1.13 mm/0.56 mm (0.044"/0.022")
	YC-A005	T5304B	ø5 mm (ø0.19")	12 mm (0.47")	0.17 mm (0.006")	0.09 mm/0.04 mm (0.003"/0.001")
	YC-A010	T5305	ø10 mm (ø0.39")	12 mm (0.47")	0.68 mm (0.026")	0.34 mm/0.17 mm (0.013"/0.006")
	YC-A015	T5306	ø15 mm (ø0.59")	12 mm (0.47")	1.51 mm (0.059")	0.76 mm/0.38 mm (0.029"/0.014")
	YC-A020	T5307	ø20 mm (ø0.78")	12 mm (0.47")	2.68 mm (0.105")	1.34 mm/0.67 mm (0.052"/0.0263")
	YC-A025	T5308	ø25 mm (ø0.98")	12 mm (0.47")	4.19 mm (0.164")	2.10 mm/1.05 mm (0.0826"/0.041")
B	YC-B020	T5428	ø20 mm (ø0.78")	12 mm (0.47")	2.68 mm (0.105")	1.34 mm/0.67 mm (0.052"/0.0263")
	YC-B025	T5309	ø25 mm (ø0.98")	12 mm (0.47")	4.19 mm (0.164")	2.10 mm/1.05 mm (0.0826"/0.041")
	YC-B030	T5310	ø30 mm (ø1.18")	12 mm (0.47")	6.04 mm (0.237")	3.02 mm/1.51 mm (0.118"/0.0452")
	YC-B040	T5311	ø40 mm (ø1.57")	12 mm (0.47")	10.89 mm (0.42")	5.45 mm/2.72 mm (0.214"/0.107")
	YC-B050	T5430	ø50 mm (ø1.96")	12 mm (0.47")	17.05 mm (0.67")	8.52 mm/4.26 mm (0.335"/0.167")
	YC-B055	T5438	ø56 mm (ø2.20")	23 mm (0.90")	16.5 mm (0.649")	8.25 mm/4.12 mm (0.324"/0.162")
	YC-B065	T5439	ø66 mm (ø2.59")	23 mm (0.90")	25.9 mm (1.019")	12.95 mm/6.48 mm (0.509"/0.255")
	YC-B085	T5440A	ø86 mm (ø3.38")	28 mm (1.10")	43.8 mm (1.724")	21.90 mm/10.95 mm (0.86"/0.43")
A	YC-A015R	T5451	ø15 mm (ø0.59")	12 mm (0.47")	1.51 mm (0.059")	0.76 mm/0.38 mm (0.029"/0.014")
	YC-A020R	T5452	ø20 mm (ø0.78")	12 mm (0.47")	2.68 mm (0.105")	1.34 mm/0.67 mm (0.052"/0.026")

*Vacuum capacity in this table shows theoretical lifting capacity. See vacuum finger regarding dimensions attached with finger. Material: NBR

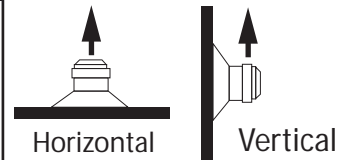
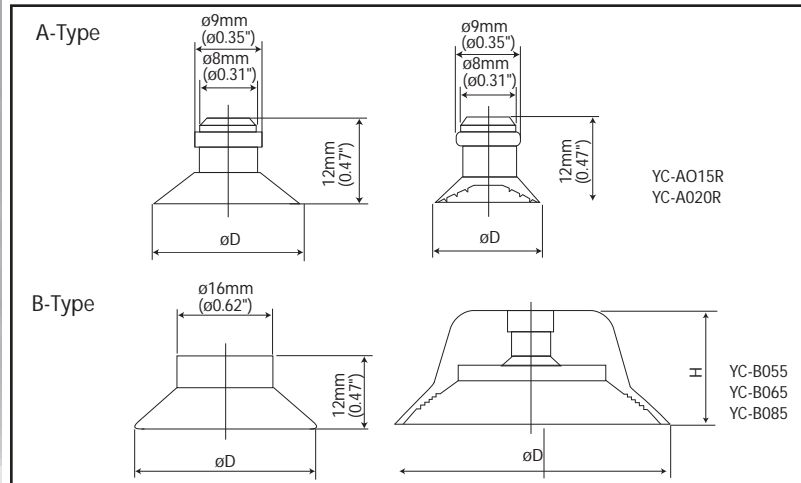

- The horizontal and vertical lifting capacity should correspond to the illustration above.
- Conditions such as dirty or oiled surfaces of workpieces should be taken into consideration.
- Vacuum capacity when measured with ORII vacuum generator at 3.5-4.0 kg/cm² of air source.

An industry leader in pressroom automation for more than 30 years, Oriimec provides robots, transfer systems, coil handling equipment and straightener/feeder combination units to customers worldwide. Manufactured in Japan, the Orii line of equipment is engineered to meet the specific needs of each of our customers. All Orii products sold in the U.S. are paired with expert service and technical support from our Erlanger, KY office.



Oriimec Corporation of America
1840 Airport Exchange Blvd. #200
Erlanger, KY 41018
U.S.A

Phone:
888.746.3320 (toll free)

Tel: 859.746.3318
Fax: 859.746.3319
Email: info@oriimec.com
Website: www.oriimec.com

VACUUM CUPS

Bellows Cups

Type	Model	Parts No.	øD	H	Lifting Capacity	Cushion
A	YC-J020	T5-6837	ø21 mm (ø0.826")	18 mm (0.708")	2.68 mm (0.105")	5 mm (0.196")
B	YC-J030	T5-6838	ø31 mm (ø1.220")	18 mm (0.708")	6.04 mm (0.237")	9 mm (0.354")
	YC-J0420	T5-3988	ø42 mm (ø1.653")	23 mm (0.905")	10.89 mm (0.428")	12 mm (0.472")
	YC-J060	T5-3895	ø62 mm (ø2.440")	27 mm (1.062")	24.9 mm (0.980")	12 mm (0.472")

*Vacuum capacity in this table shows theoretical lifting capacity
See vacuum finger regarding dimensions attached with finger.
Material: NBR

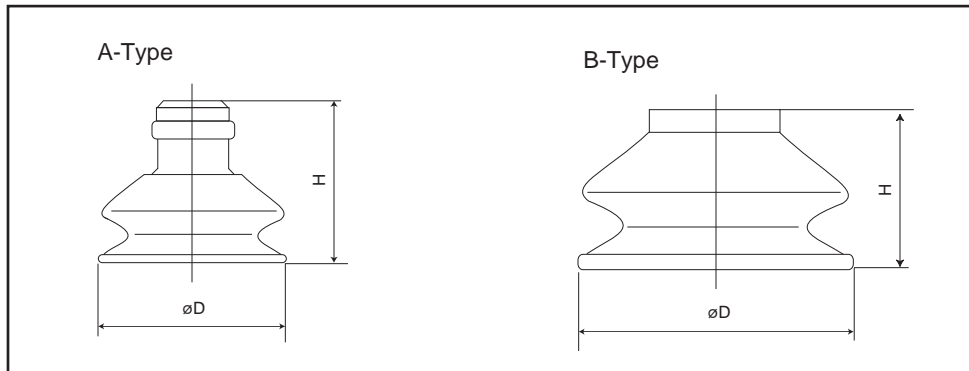

Magnet

Used when vacuum pick is unsuitable, magnets should be fitted with the universal holder or magnet holder.

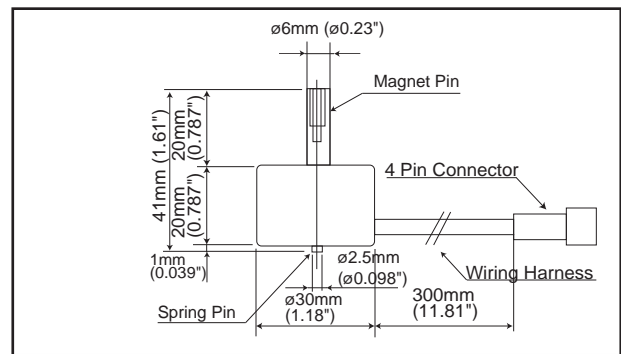
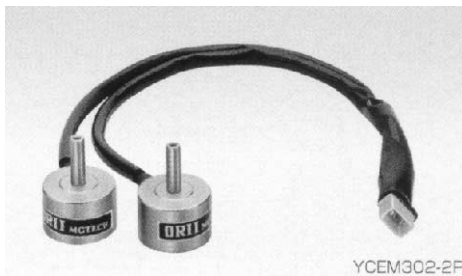

Model	Parts No.	øD	H	Current(A) /p.c.s	Voltage	Vacuum Capacity	Magnet/ Connector
YCEM301-2P	T5397	ø30 mm (ø1.18")	20 mm (0.787")	0.24	DC24 V	2 kg (4.4 lbs)	1/2P
YCEM301-4P	T5403	ø30 mm (ø1.18")	20 mm (0.787")	0.24	DC24 V	2 kg (4.4 lbs)	2/4P
YCEM302-2P	T5404	ø30 mm (ø1.18")	20 mm (0.787")	0.24	DC24 V	2 kg (4.4 lbs)	2/2P
YCEM302-4P	T5405	ø30 mm (ø1.18")	20 mm (0.787")	0.24	DC24 V	2 kg (4.4 lbs)	2/4P

An industry leader in pressroom automation for more than 30 years, Oriimec provides robots, transfer systems, coil handling equipment and straightener/feeder combination units to customers worldwide. Manufactured in Japan, the Orii line of equipment is engineered to meet the specific needs of each of our customers. All Orii products sold in the U.S. are paired with expert service and technical support from our Erlanger, KY office.



Oriimec Corporation of America
1840 Airport Exchange Blvd. #200
Erlanger, KY 41018
U.S.A

Phone:
888.746.3320 (toll free)

Tel: 859.746.3318
Fax: 859.746.3319
Email: info@oriimec.com
Website: www.oriimec.com